



COMPACT DESIGN
BIG PERFORMANCE

EN

G1500

STANDARD / X-TRA



GiANT[®]
BY TOBROCO

WWW.TOBROCO-GIANT.COM



G1500

STANDARD / X-TRA



TYPES	G1500	G1500 X-TRA
Service weight ¹	1.480 kg	1.525 kg
Lifting capacity	1.100 kg	1.400 kg
Tipping load	965 kg	1.485 kg
Lifting height	2.558 mm	2.067 mm
Length without bucket	2.669 mm	2.718 mm
Width	890 mm	1.100 mm
Machine height	2.230 mm	2.230 mm

¹ Measured with earthbucket.

DISTINCTIVE POWER

These TOBROCO-GIANT compact wheel loaders offer high performance and versatility, combined with low operating costs and fuel consumption. The G1500 models feature individual wheel motors for stability, maneuverability and productivity.

The G1500 models are compactly designed with impressive performance. TOBROCO-GIANT has developed the G1500 models entirely in-house and only works with the best components from suppliers such as Kubota, Bosch Rexroth, Comer and Hydac.

STRONG CHARACTERISTICS



- 1. WORKING COMFORTABLY** - A spacious and comfortable working environment.
- 2. WORK SAFELY** - The cabin and safety roof are ROPS/FOPS certified on international standard.
- 3. EASY SERVICE** - Maintenance on the G1500 is easy to perform because the maintenance points are easy to access.
- 4. POWERFUL PERFORMANCE** - A reliable 3-cylinder, Kubota engine without DOC and DPF ensures powerful performance.
- 5. COMPACT DESIGN** - The compact design of the G1500 makes it possible to work in tight spaces.
- 6. MANEUVERABILITY AND STABILITY** - The articulated pendulum system ensures maneuverability and stability.
- 7. PRODUCTIVITY** - Hydrostatic 4-wheel drive with automotive control and 4 heavy Poclain wheel engines.
- 8. HYDRAULIC POSSIBILITIES** - The standard version with double-acting function at the front (mechanically operated) can easily be expanded with additional hydraulic functions and a tandem pump.
- 9. SPEED** - 0-12 km/h (higher driving speed 0-19 km/h).
- 10. CHOOSE THE MACHINE FOR YOUR WORK** - Depending on the work, you can opt for a standard or X-TRA variant with associated options.

TOP PERFORMANCE



“In particular, the powerful engine and higher lifting power are of great importance to us. Our machine park now consists of 6 GIANTS between 1,100 and 3,800 kg.” - Schuurman Pavement BV

POWERFUL ENGINE

The G1500 is powered by a powerful 26 hp diesel engine, without DOC and DPF, which meets the latest EU Stage V emission standards. To guarantee performance and comfort, TOBROCO-GIANT has equipped the machine with 4 heavy-duty wheel motors and an electrically switchable differential lock. This power train ensures maximum grip, a lot of pulling force and smooth movement in each situation while one benefits of reduced running costs and less fuel consumption.

STRONG WORKING HYDRAULICS

The hydraulic system of the G1500 models is controlled directly via the joystick. With 42 ltr/min (170 bar) it is more than sufficient to drive a large number of attachments. If work demands it, the work hydraulics can be further expanded with additional double-acting functions and an electrically switchable tandem pump.



G1500



G1500 X-TRA

COMPACT DESIGN



“The wheel loader replaces manual labor that used to be done with a pushcart. It requires heavy work from the employees and increases our performance.”

Stefan Krebber, entrepreneur, gardener and landscape architect



G1500

STABILITY AND MANEUVERABILITY

The articulated pendulum system gives the G1500 a lot of stability and manoeuvrability. The system ensures that all four wheels always remain on the ground, even when working on uneven terrain. This not only makes work safer, but also ensures sufficient traction at all times.

Despite its compact dimensions and low operating weight, the standard G1500 has a tipping load of 1,040 kg and a lift height of 2.56 metres. The G1500 X-TRA lifts to a height of 2.07 meters and has a tipping load of 1,500 kg. The standard width of 89 cm for the G1500 and 110 cm for the G1500 X-TRA makes it possible to work indoors, on narrow paths or in places with limited space.



G1500 X-TRA

While working with heavy loads the machine still holds an extraordinary stability against overturning. This is due to the four-wheel engines, which take the balance point of the machine to a very low level. For extra productivity it is possible to equip the machines with the patented Stabilo System or boom suspension. Both options provide extra safety and comfort because unevenness's are absorbed without any compromise to the performance.

SAFETY AND COMFORT



The machines are equipped with a safety roof as standard and can optionally be expanded to a full-option cabin. The G1500's spacious cab is easy to access and designed according to user's needs: The steering column is adjustable in depth and equipped with a dashboard where all necessary information can be easily found. The mechanically suspended seat is luxuriously designed and easy to adjust for good posture. While using the multifunction joystick, the operator can rest his arm on an ergonomically shaped armrest. Important buttons are within easy reach on and next to the joystick.



360° all-round visibility from the cabin

The G1500 machines have been thoroughly tested for safety by an independent institution and internationally certified for ROPS/FOPS protection. The operator's central position and the use of narrow stiles and a skylight provide 360-degree visibility all around and on the attachment. This ensures that work can be performed efficiently and accurately.



ELECTRONIC CONTROL

Information about engine temperature and other indicators can be checked via the dashboard so that the driver can always see these important data during work.

ATTACHMENTS

500+ attachments

Our attachments are developed entirely in-house so that they deliver the best results when working on our machines. TOBROCO-GIANT offers more than 500 different attachments so your machine can be used all year long. By choosing the right attachment it is possible to adjust your GIANT to working conditions for agricultural purposes, construction, material handling, private use and many other areas of application. Get every job done with just one machine!

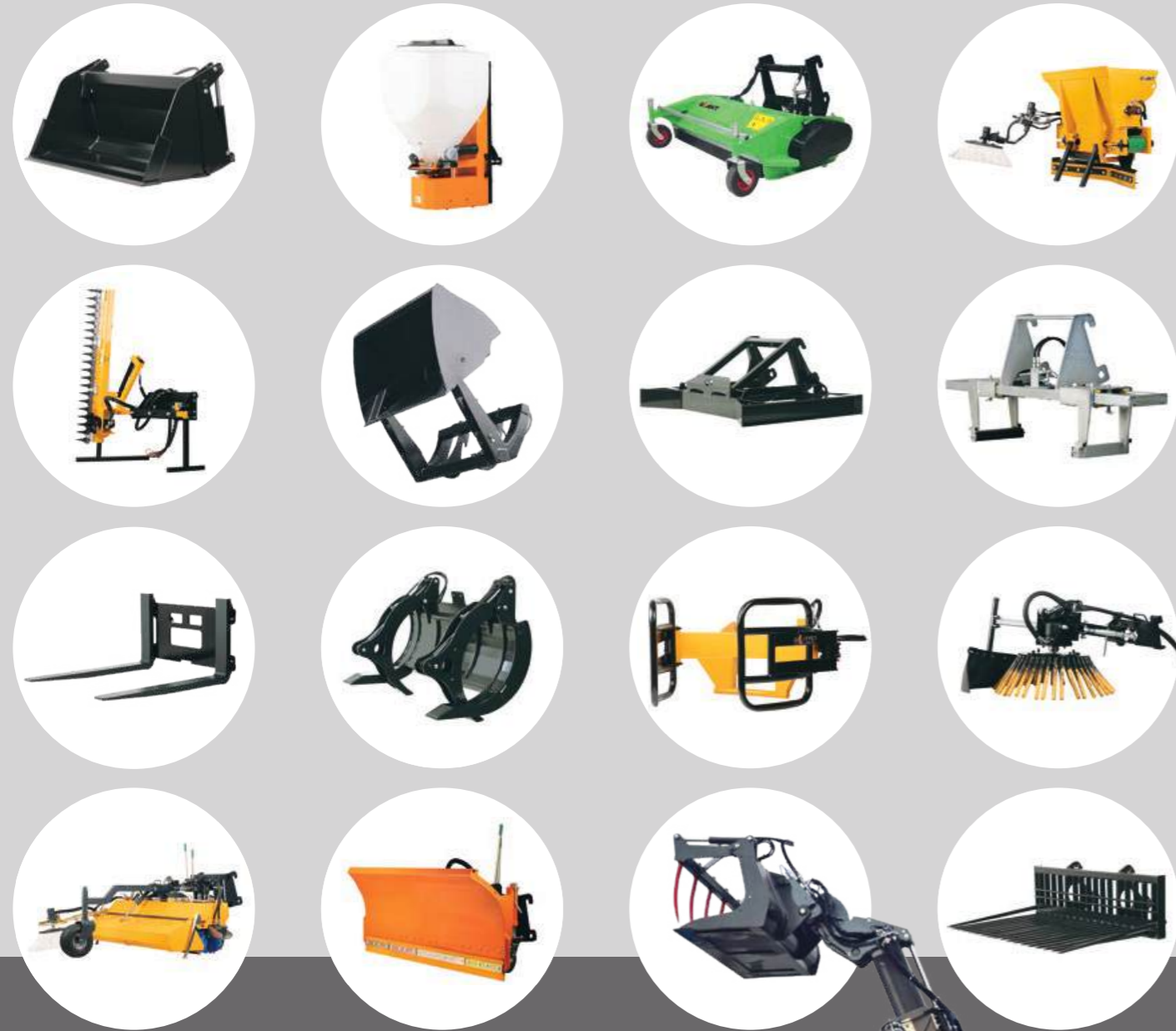

HYDRAULIC QUICK COUPLER

The G1500 models are checked via equipped with a hydraulic quick coupler as a standard. This makes it possible to change attachments safely and within seconds.

MOUNTING SYSTEMS

TOBROCO-GIANT offers a wide range of mounting systems, enabling you to use the attachments that you already have.



SECTORS

One machine for every job



 INFRASTRUCTURE



 AGRICULTURAL



 CONSTRUCTION & DEMOLITION



 EQUINE INDUSTRY



 FORESTRY



 GOVERNMENT & MUNICIPALITIES



 MATERIAL HANDLING



 NURSERIES



 WINTER SERVICE



 LANDSCAPING & GROUND CARE

SPECIFICATIONS

TECHNICAL DATA

TYPE	G1500	G1500 X-TRA
Service weight ¹	1.480 kg	1.525 kg
Lifting capacity	1.100 kg	1.400 kg
Tipping load ²	1.040 kg	1.500 kg

DIMENSIONS AND SPEED

Lifting height ³	2.558 mm	2.067 mm
Length without bucket	2.669 mm	2.718 mm
Machine height ³	2.230 mm	2.230 mm
Width on standard tyres	890 mm	1.100 mm
Standard tyres	7.00 x 12 AS	26 x 12.00-12 AS
Travel speed	0-12 km/h	0-12 km/h

ENGINE

Kubota D1105 (STAGE V)

Cylinders	3	3
Engine power	26 HP / 19 kW	26 HP / 19 kW
Type	Diesel	Diesel
Fuel tank capacity	25 ltr	21
Oil capacity	41 ltr	41

POWERTRAIN

Type	Hydrostatic four wheel drive	
Transmission	Automotive control	
Differential	Electric controlled length differential lock	
Final drive	4 heavy Poclain wheel engines	
Pulling force	9.200 N	
Driving hydraulics	84 ltr/min (350 bar)	84 ltr/min (350 bar)
Working hydraulics	42 ltr/min (170 bar)	
Parking brake	Hydraulic multidisk brake (electric controlled)	

STANDARD MACHINE FEATURES

TYPE	G1500	G1500 X-TRA
GIANT hydraulic quick change system	Std	Std
ROPS/FOPS safety roof incl. safety doors left and right	Std	Std
Luxury seat incl. safety belt, armrest and extended backrest	Std	Std
1x Double acting hydraulic function, mechanical	Std	Std
Floating position on lifting cylinder(s)	Std	Std
1x Working light (haogen) front, on lifting arm	Std	Std
Main switch	Std	Std
Shunt coupling	Std	Std
Cyclone filter	Std	Std
Oil cooler	Std	Std

¹ Measured with earthbucket

² Measured with hinge point in straight position on standard tyres

³ Measured on standard tyres with safety roof

MEASUREMENTS

	UNIT	G1500	G1500 X-TRA
A Wheelbase	mm	1.368	1.419
B Total length	mm	2.669	2.718
C Length with bucket	mm	3.360	3.389
D Length 3 point hitch	mm	622	622
E 3 point hitch in lowest position	mm	74	74
F 3 point hitch in highest position	mm	737	737
G Seat height	mm	1.136	1.136
H Max. height with safety roof	mm	2.230	2.230
I Max. height with cabin	mm	2.220	2.220
J Height front frame	mm	1.550	1.148
K Max. dumping height	mm	1.827	1.360
L Lifting height	mm	2.558	2.067
M Height with bucket	mm	3.138	2.641
N Rollback angle on the ground	degrees	41	44
O Rollback angle at max. lift height	degrees	52	55
P Max. angle for bucket emptying	degrees	44	41
Q Drive-up angle	degrees	27	27
R Outer size of tyres	ø mm	670	670
1A Turning radius with bucket	mm	2.257	2.469
1B Turning radius on outer edge	mm	1.900	2.263
1C Inner turning radius	mm	1.040	1.163
1D Width on standard tyres	mm	890	1.100

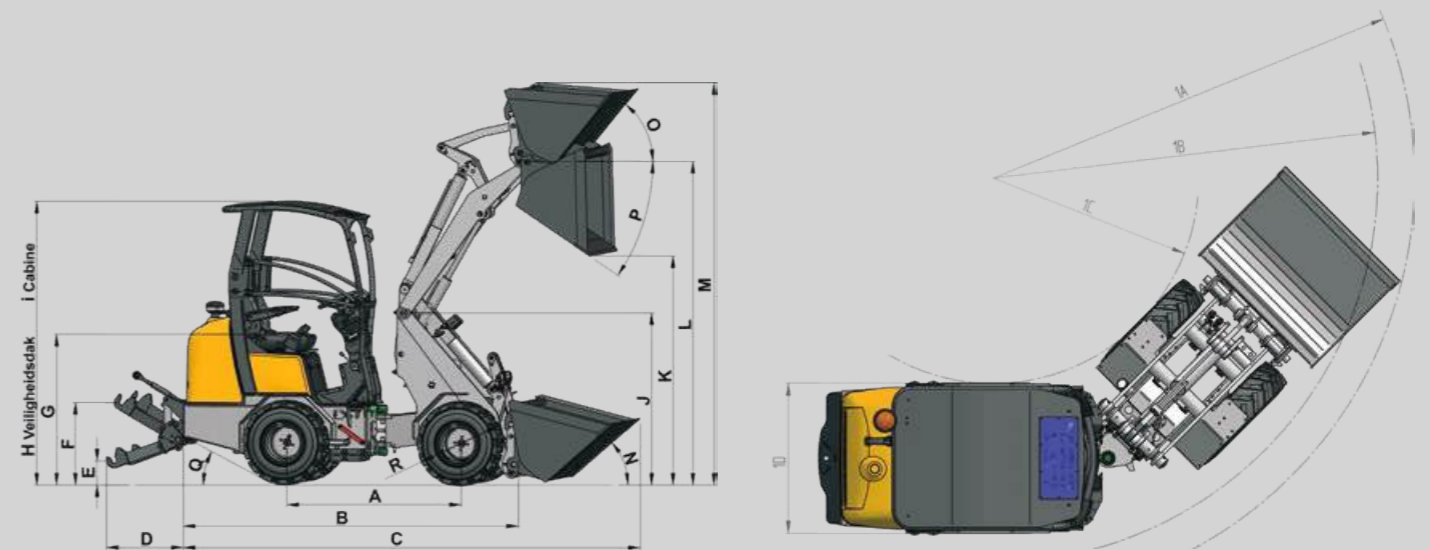

TIPPING LOADS

	G1500	G1500 X-TRA
S	965 kg	1.485 kg
T	890 kg	1.340 kg
U	690 kg	970 kg
V	535 kg	845 kg
W	1.690 kg	1.775 kg
X	1.140 kg	1.210 kg
Y	800 kg	855 kg



Tipping load = without counterweights. Measured with GIANT hitch. The above values may deviate for other types of hitches.

AVAILABLE OPTIONS

	G1500	G1500 X-TRA
SAFETY ROOF/CABIN		
ROPS/FOPS safety roof deluxe incl. safety doors, 2 side mirrors, 2 working lights front and 2 rear	0	0
ROPS/FOPS foldable safety roof incl. safety roof (clearance height with folded safety roof: 1.845 mm)	0	0
ROPS/FOPS foldable safety roof deluxe incl. safety doors, 2 side mirrors, 2 working lights front and 2 rear	0	0
ROPS/FOPS cabin incl. heating, radio and speakers, 2 side mirrors, 2 working lights (halogen) front and 2 rear	0	0
DAB+ radio and speakers (Bluetooth and USB 2.0 connection)	0	0
Cabin mat	0	0
Side mirrors (L+R)	0	0
ROPS roll bar conversion set	0	0
HYDRAULIC CONNECTIONS ON LIFTING ARM		
Transport securing device	0	0
Hose rupture protection on lift and top cylinder (floating position not possible)	0	0
Hose rupture protection on lift and top cylinder + floating position + transport securing device	0	0
1x extra double acting hydraulic function, mechanical	0	0
1x extra double acting hydraulic function, electric/hydraulic in joystick	0	0
2x extra double acting hydraulic function, electric/hydraulic in joystick	0	0
Electrically switchable tandem pump, max. 33 ltr/min	0	0
Single- or double-side hydraulic hold on additional function	0	0
Leak oil connection	0	0
Free hydraulic return	0	0
HYDRAULIC CONNECTIONS AT THE BACK OF THE MACHINE		
1x extra double acting hydraulic function, mechanical	0	0
1x extra double acting hydraulic function, electric/hydraulic in joystick	0	0
Electrically switchable tandem pump, max. 33 ltr/min	0	0
Leak oil connection	0	0
Free hydraulic return	0	0
Three point lifting mechanism (Cat. 1)	0	0
ELECTRICAL/LIGHTING		
Switched 12 Volt socket, 3-pin (max. 2)	0	0
13-pin trailer socket to the back (only possible in combination with traffic lights)	0	0
Additional working light (halogen or LED) front, on lifting arm (max. 2)	0	0
Additional working light (halogen or LED) to the front of safety roof (max. 2)	0	0
Additional working light (halogen or LED) behind the seat (max. 2)	0	0
Flashing/warning light (halogen or LED) mounted on safety roof (max. 2)	0	0
2x flashers (LED) front + 2x flashers (LED) rear	0	0
Traffic lights (halogen or LED)	0	0
License plate holder with illumination	0	0
OTHER OPTIONS		
Machine sprayed in RAL company colour	0	0
HD driving mechanism (12.500 N pulling force)	0	0
Higher driving speed (0-19 km/h)	0	0
Four wheel drive differential lock	0	0
Hand throttle	0	0
Hand inching	0	0
Pro-inching	0	0
STABILO system (patented)	0	0
Back-up alarm (acoustic)	0	0
Jump start	0	0
Mudguard wideners	0	0
Towing hook (shunt coupling cancelled)	0	0
Tow ball (in combination with counterweight at the back (90 kg))	0	0
Combination towing hook (towing hook + tow ball)	0	0
Counterweight at the back (90 kg) incl. standard shunt coupling	0	0
Counterweight 40 kg (max. 4 pcs) under chassis	0	0
Different hitch	0	0
Boom suspension	0	0
Parallel indicator on tilt cylinder	0	0
Engine heater (Coolant), 110V or 220V	0	0
Document box	0	0
Panolin HLP Synth 46 biologisch afbreekbare hydraulische olie	0	0
Road specification (ask your dealer for details)	0	0

MAINTENANCE & SERVICE

MAINTENANCE



Performing maintenance to the G1500 is no problem at all because the service points are easy to reach. Filters, hydraulic system and engine can be freely accessed via the easy-to-open bonnet, tilting cab or other service panels. This ensures that daily checks and maintenance can be carried out quickly and in a safe manner.

GENUINE GIANT PARTS



The usage of genuine GIANT parts ensures reliable, efficient and safe operation of your machine. We only use the best quality components and test them severely before we introduce a new model. All these parts are vital for the best possible performance and minimising downtime. Keeping your GIANT 100% original saves money for the owner because of reduced maintenance costs and results in a higher resale value once the machine is resold.

SERVICE & SUPPORT



At TOBROCO-GIANT we offer support, service and high quality parts to protect the investment that you have made in GIANT machinery. Together with our dealers we are available to make sure that your machine performs in the best possible way. This increases your productivity and will result in an even better return on your investment.

TRAINING



At TOBROCO-GIANT we know all the details about our machines. That is why we offer an extensive training program to our dealers. Not only on the newest features or attachments, but also on how to service a machine to the highest standards.



Quality - Growth - Innovation - Integrity -
Customer Oriented - Enterprising

*“Developed in
The Netherlands, built for
the world”*



Within 25 years, TOBROCO-GIANT has grown into a global player in compact machines with one of the broadest portfolios in the industry. The wide range of implements ensures that all work can be carried out with one machine. This means that GIANT machines can be used all year round for all kinds of work.

In a modern factory in the Netherlands, machines and attachments are developed and produced in-house. By using the most modern technology, ensuring continuous innovation and applying the best components from Kubota, Bosch Rexroth and Comer, GIANT machines and attachments are produced with the greatest care and quality.

Every day, the team of more than 500 employees in the Netherlands, Hungary and America focuses with passion and enthusiasm on complete customer satisfaction.

THE FUTURE IS ELECTRIC

The demand for compact electrical equipment is an unstoppable trend. With Jungheinrich, TOBROCO-GIANT has found a global and reliable partner with expertise when it comes to developing electrical machines. Everything is aimed at developing an electric version of each GIANT along to the diesel version in the long term.

DEALER NETWORK

With a large network of dedicated dealers we like to be close to our customers to provide the machines, service and parts that you demand. All dealers are supported by a team of experts from the head office of TOBROCO-GIANT in Oisterwijk, The Netherlands.

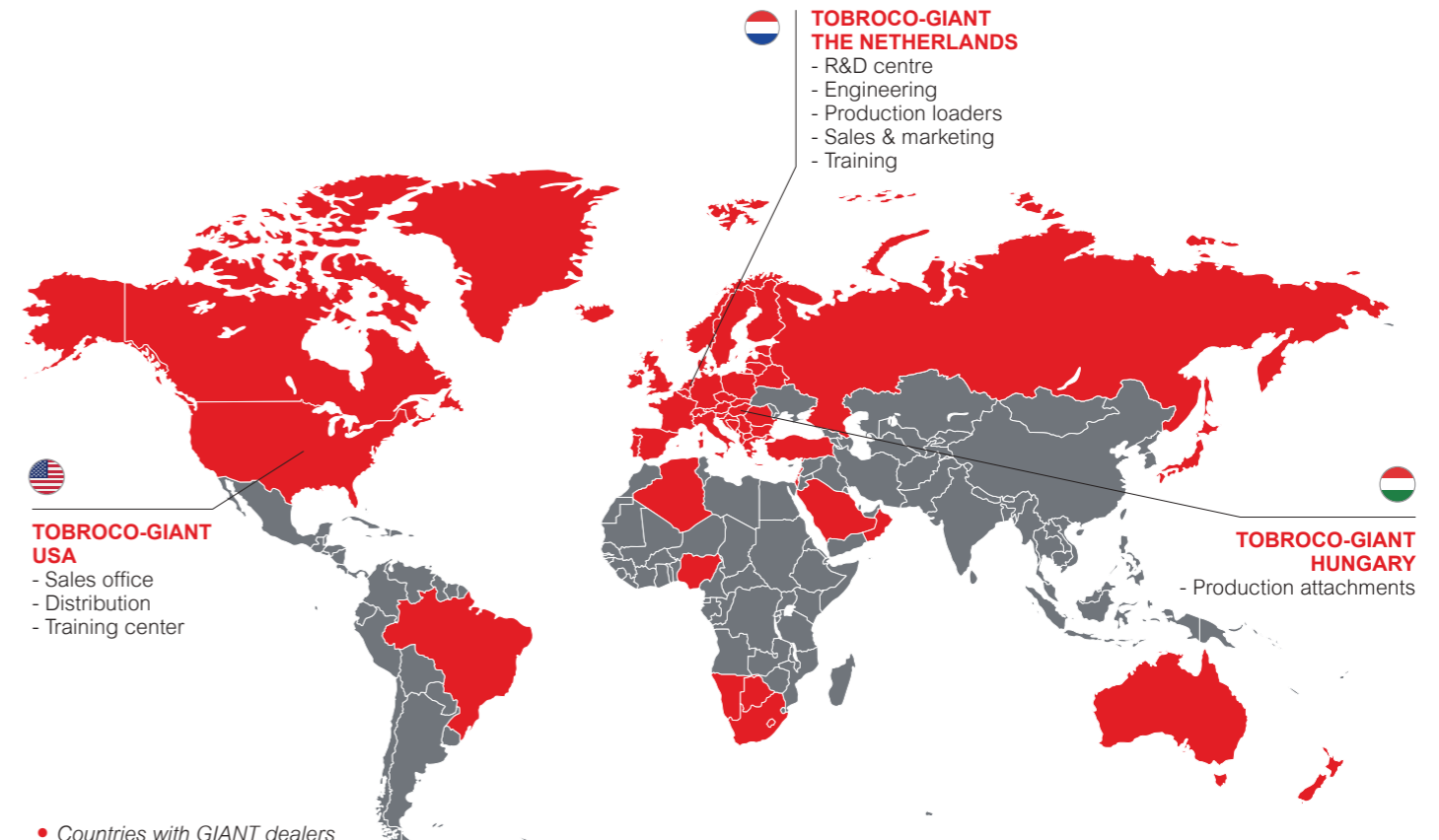

ALL MODELS

TOBROCO-GIANT has been manufacturing high-quality GIANT machines and attachments since 1996 when we opened our first factory in The Netherlands. Today, TOBROCO-GIANT offers one of the broadest product portfolios in the business with 35 different models sold in 60 countries. In addition to machines with motors from 20 hp to 76 hp, TOBROCO-GIANT also supplies electrical machines and a complete line of compaction machines. TOBROCO-GIANT grows into a full-liner in compact and durable equipment.



SK212G
SK202D
SK252D



G1100 (TELE)
G1200 (TELE)



G1500 (X-TRA)



G2200E (X-TRA) 



G2300 (X-TRA) HD



G2500 (X-TRA) HD



G2700 (X-TRA) HD
G2700 (X-TRA) HD+
G2700E (X-TRA) 



G3500 (X-TRA / TELE)



G5000 (X-TRA / TELE)



GT5048



VIBRATORY PLATES
E-VIBRATORY PLATES 



VIBRATORY RAMMERS
E-VIBRATORY RAMMERS 



REVERSIBLE VIBRATORY PLATES
E-REVERSIBLE VIBRATORY PLATES 

 Electric



GIANT[®]
BY TOBROCO

TOBROCO-GIANT

Sprendlingenstraat 57, 5061 KM Oisterwijk (The Netherlands)

Tel.: +31 (0)13-5211212 | Fax: +31 (0)13-5234045

Internet: www.tobroco-giant.com | E-Mail: info@tobroco-giant.com



CONNECT WITH US

All technical data in this brochure refer to under Central European operating conditions tested series models and describe the standard functions. Specifications and their modes of operation, as well as accessories, depend on the model and the options of the product, as well as country-specific regulations in the country of sale. Images may show non-listed or non-standard available products. The descriptions, illustrations, weights and technical data are not binding and are in accordance with the state of the art at the time of going to press. Changes in the design, equipment, optics and technology are due to the continuous development of its products without prior notice. Do you need special functions which are only available through the use of additional components and / or under special circumstances, please contact us! We will be happy to answer your questions and let you know whether and under what conditions regarding the product and the environmental conditions special functions are realizable. When doubts about the capacity or the performance of our products under special circumstances, we recommend to perform under controlled conditions. Testing activities despite the utmost care, we cannot rule out deviations from illustrations or dimensions, calculation errors, misprints or omissions in this brochure. We therefore accept no liability for the correctness and completeness of the information contained in this brochure. As part of our General Terms and Conditions, we guarantee the proper functioning of our products. Furthermore Linear guarantees we provide in principle. A further liability than outlined in our Terms and Conditions is excluded.

